

CITY TOP K

10/2020



Green Heating Technology

ITALTHERM

- New Condensing exchanger with bigger water flow
- I.C.S. (Intelligent Combustion System) which manages automatically Combustion
- Gas Conversion without components replacement
- Modulation Range 1:20 (35kW) - 1:15 (25kW)
- Hydraulic Brass Group with DIN connections
- Automatic water filling

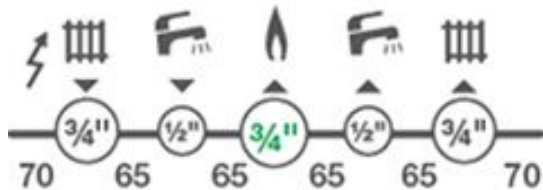

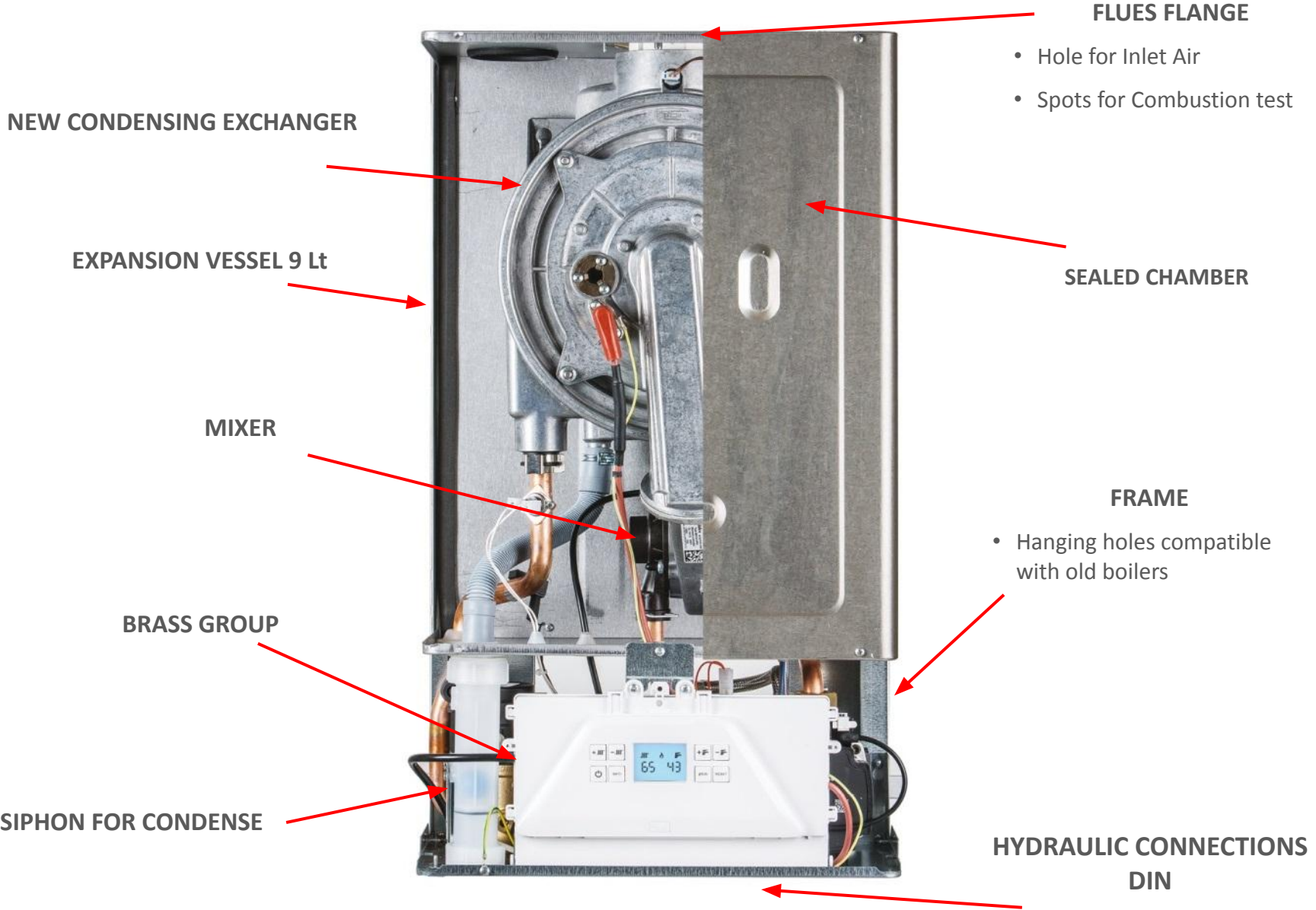

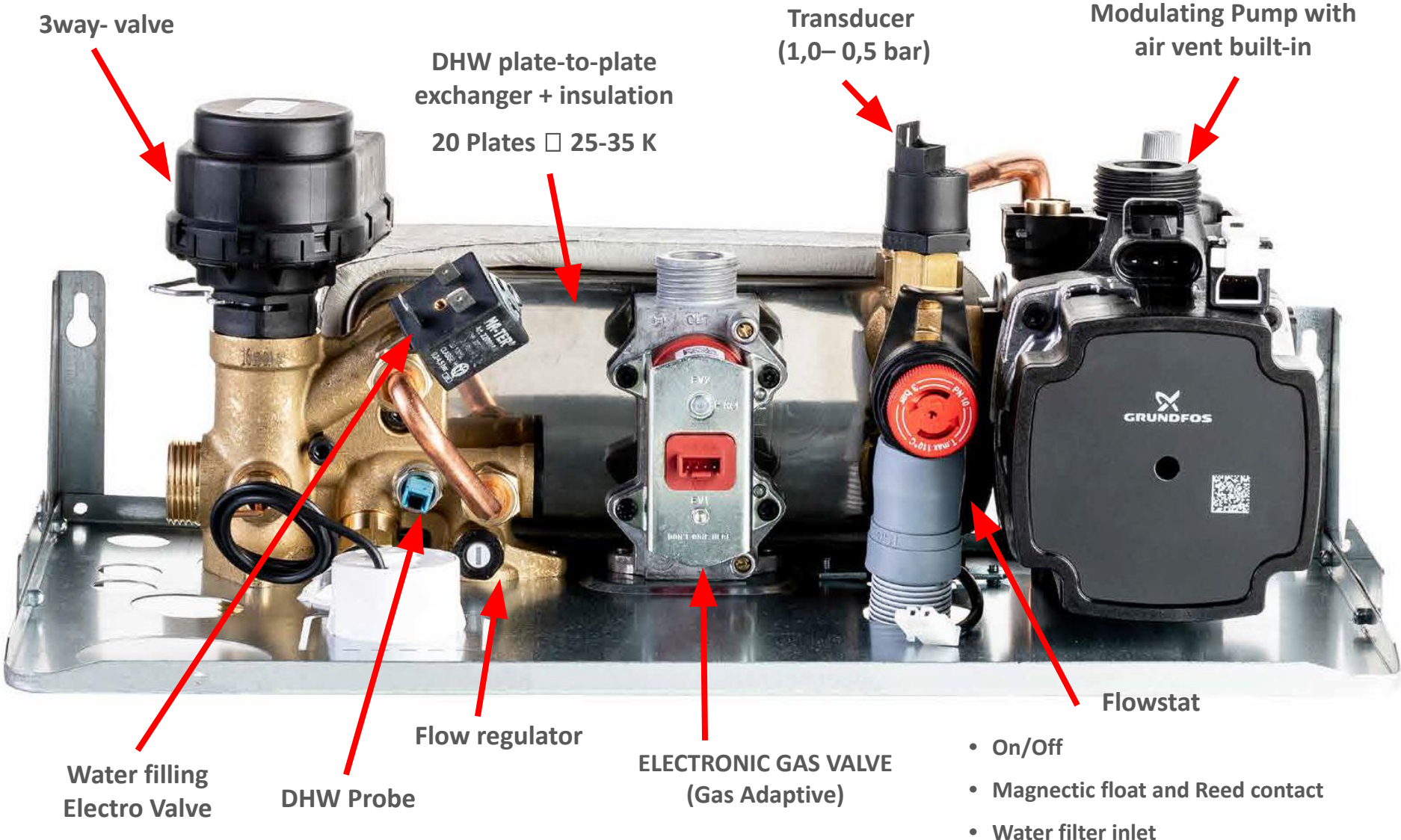

- External parts in **aluminium** □ lower boiler weight
- Single coil in Stainless steel **AISI 441**
- Kind of Teflon as material in contact with Condense
- Single Electrode for Detection and Ignition

(Distance from Burner = 4 mm)

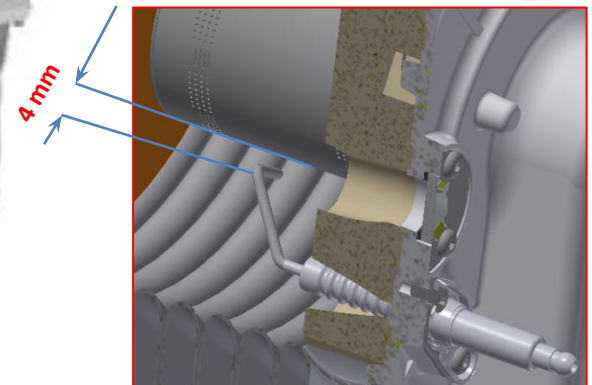
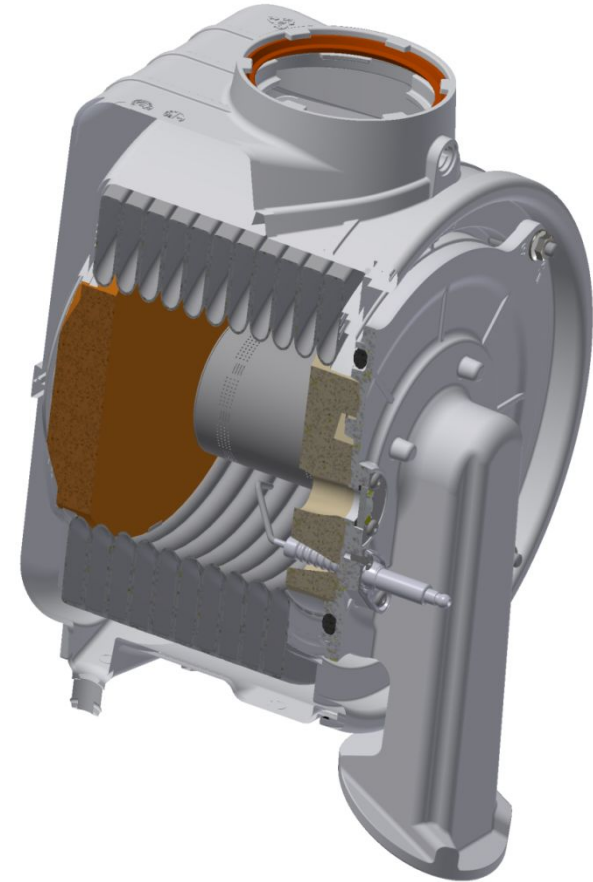

- Coil Section **bigger**
- Better **resistance** to **scale** and **dirty deposit** from plant
- Ideal for **replacements** on existing installations and old plant
- No parallel coils means better cleaning
- No welding points
- Lower risk of water leakage

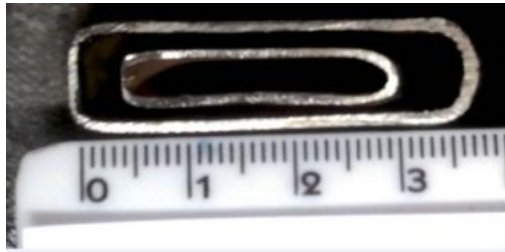

Coil Section City Top K

Coil Section City Plus K

I.C.S □ INTELLIGENT COMBUSTION SYSTEM

1



System ICS allows combustion calibration and check, completely electronic.

2



Boiler is calibrated in Production.
On the field, ICS system keeps on cheking and calibrating boiler in order to always get best working conditions.

3



Gas Valve receive electronic input from PCB in order to change its working.

No mechanical calibration is required

ADVANTAGES SYSTEM I.C.S.



HIGH MODULATION RANGE



GAS ADAPTIVE FUNCTION

Easy gas change: no components replacements, only Parameter change



ALWAYS BEST POSSIBLE COMBUSTION

= better efficiency and less consums

= Less polluting emissions



LESS INSTALLATION TIMING

No manual operation for Boiler Calibration

Nozzle*

∅ 6 □ 25 - 35 kW

The same nozzle for both power

Gas Change: acting only to Par.1
 Par 1 = 0 □ G20 (Natural Gas)
 Par 1 = 1 □ G31 (Propane)

*green side on the bottom (to gas valve)

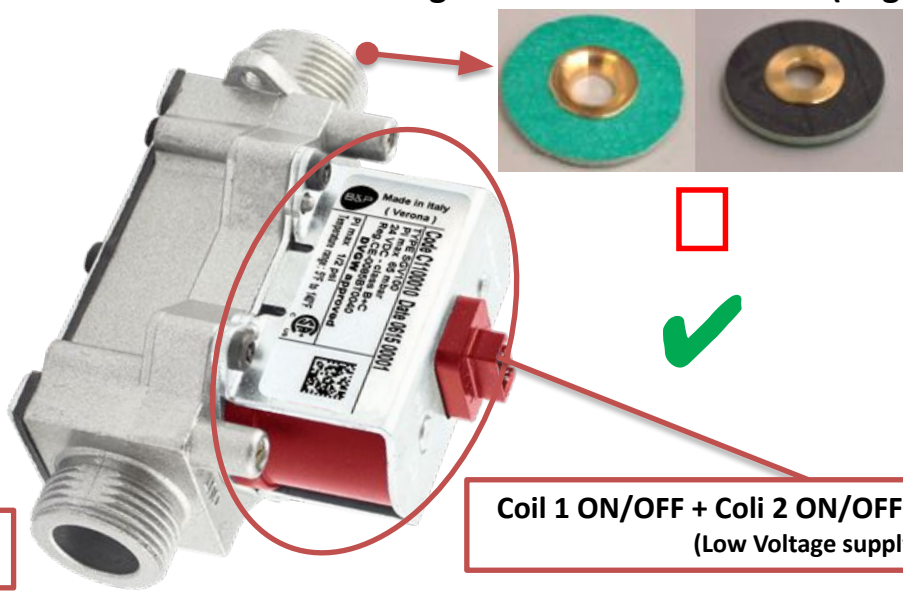



Coil 1 ON/OFF + Coils 2 ON/OFF and modulating
 (Low Voltage supply)

Combustion Calibration table values

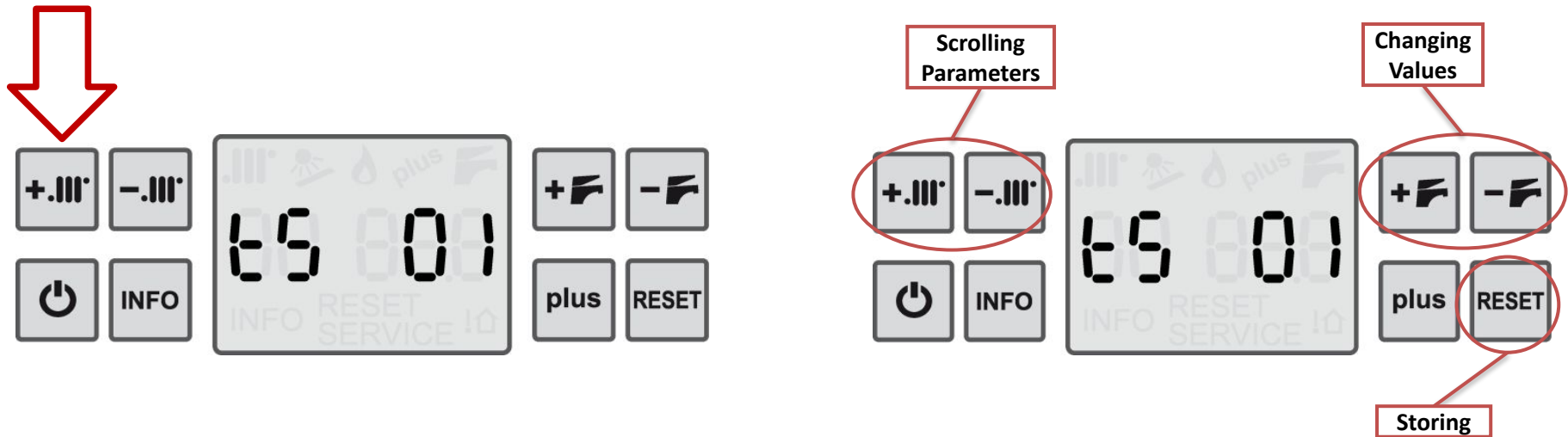
Mod.	Heat input	Natural gas G20		Commercial Propane G31		Air/Propane G230	
		CO ₂ at Q _n and ignition (%)	CO ₂ at Q _{min} (%)	CO ₂ at Q _n and ignition (%)	CO ₂ at Q _{min} (%)	CO ₂ at Q _n and ignition (%)	CO ₂ at Q _{min} (%)
25	Nominal value	9.2	8.5	10.3	10.1	10.4	10.3
	Allowed range	8.2...9.7	8.0...9.0	9.5...11.0	9.0...11.0	9.5...11.0	9.0...11.0
35	Nominal value	9.2	8.5	10.2	10.1	10.1	10.0
	Allowed range	8.2...9.7	8.0...9.0	9.5...11.0	9.0...11.0	9.5...11.0	9.0...11.0



1. Boiler Mode selected (summer or winter)
2. Keep pushing buttons **+.III** , **+F** for 10 sec. until display is showing on the **left «tS»** flashing alternatively with a number (n° of Parameter) and on the **right** a number which is the value of Parameter selected.
3. Pressing **+.III** , **-.III** for scrolling Parameters.
4. Pressing **+F** , **-F** for changing Parameter values
5. Storing values changed pressing button  for 3 sec.
6. Parameter Access still be active for 15 min; exit function pressing 

Color Key

Standard Parameter for general uses

Suggested to not modify

Param	Description	Range	Factory Settings	Note
01	Type Gas	0 – 1	0	0 – G20 1 – G31
02	CH Temperature Range	0 - 1	0	0 – Standard Range 35 ÷ 80 °C 1 – Reduced Range 20 ÷ 45 °C
03	Slow Ignition Fan Revolution	80 – 160	Kind of boiler	Value in RPM = PAR03 x 25
04	Max CH power inlet	00 – 100	Kind of boiler	Percentage of Max Power inlet available. Changing this Parameter will switch ON boiler
05	Pump mode on CH demand	0 – 2	0	0 – Standard Functioning 1 – Pump always ON 2 – Pump always OFF
06	Dealy of re.ignition in CH demand	0 – 15	3	Value in minutes
07	Service Plant function activation	0 – 3	0	0 – Disabled 1 – Bleeding plant CH side 2 – Bleeding plant DHW side 3 – Bleeding plant both CH and sides
08	on/off Temperature on DHW demand	1 - 2	1	1 – fixed <input type="checkbox"/> OFF= 75°C , ON = 65°C 2 – SETpoint <input type="checkbox"/> OFF = SanSet + 3° ; ON = SanSet + 2°
09	Timing to reach the maximum power in CH demand	2 - 12	3	Time in Seconds (PAR x 10 sec)
10	Timing to reach the maximum power on CH demand after OFF for high temperature	1 – 10	2	Time in Minutes

Param	Description	Range	Factory Settings	Note
11	Pre-heating setting	1 - 3	1	1 : T on = 25° C ; T off = 45° C 2 : T on = 30° C ; T off = 45° C 3 : T on = 35° C ; T off = 50° C
12	Chimney Sweeper function	0 - 2	0	0 – Function Disabled (normal working) 1 - Boiler forced at Max Power 2 – Boiler force d to Min Power
13	Min Fan Revolutions	-	-	RPM = Parameter x 100 - DO NOT MODIFY THIS VALUE
14	Max Fan Revolution	-	-	RPM = Parameter x 100 - DO NOT MODIFY THIS VALUE
16	Post Ventilation after demand	1 - 30	3	Seconds. Value x 10.
17	TA2 contact management	0 20 - 80	0	0 : Telephone Controller 20-80 : T Flow for Demand from this contact (TA2)
18	CH demand Min Power	0 - 30	0	Percentage of Max Power
19	Delay of switching ON after CH demand	0 - 5	0	Minutes. Timing before Boiler CH activation after receiving CH demand
20	Timing of pump fonctionning after CH demand	0 - 240	30	Seconds. Post-Circulation after CH demand
21	Timing of pump fonctionning after DHW demand	0 – 3 K. 0 – 240 KR.	0 180	Seconds. Post-Circulation after DHW demand
22	Delay of operating time for error E24 (clacson low temp)	0 5 – 120	0	0 : Function disabled 5-120 : delay in seconds
24	Max DHW Power	0 – 100	100	Percentage of Max Power





Param	Description	Range	Factory Settings	Note
33	Modulating Pump on CH demand	0 - 3	0	0 – Disabled 1 – with fixed ΔT (Par. 34) 2 - with dynamic ΔT (it sets Par 34 based on CH demand range Temperature on TA1 and TA2) 3 - based on Boiler Power
34	Modulatin Pump ΔT setting	0 - 3	0	0 – $\Delta T = 20^{\circ}\text{C}$ 1 – $\Delta T = 15^{\circ}\text{C}$ 2 – $\Delta T = 10^{\circ}\text{C}$ 3 – $\Delta T = 5^{\circ}\text{C}$
35	Max Pump circulation speed	65 - 99	Kind of boiler	Based on Boiler Power
36	Pressostat /Trasduder for plant pressure	0-4	2	0: pressostat ON/OFF 1: transducer ON=0,7 bar ; OFF= 0,4 bar 1: transducer ON=1,0 bar ; OFF= 0,5 bar 1: transducer ON=1,2 bar ; OFF= 0,8 bar 1: transducer ON=1,4 bar ; OFF= 0,9 bar
37	Water filling type	0 1 - 10	5	0 - manual filling 1-10 automatic filling; minutes before E19
38	Max SET CH temperature on TA1 or TA3	20 - 80	80	Limit when External probe is present: T Set is calculated
39	Offset External probe	0 - 10	5	0 = -5°C 5 = 0°C 10 = $+5^{\circ}\text{C}$
41	Min SET CH temperature on TA1 or TA3	20÷50 20÷35	35 20	Degrees. STANDARD Range→ DEFAULT = 35°C REDUCED Range→ DEFAULT = 20°C
46	AUX contact management	0 - 2	0	0: Low Temperature floor plant safety Thermostat 2: TA3 contact (same CH T flow set as TA1)
49	Flues Calibration	0 – 5	0	0 : MANUAL 5 : AUTOMATIC

Param	Description	Range	Factory Settings	Note
50	Service Function by Hours	10 - 99	50 (about 2 years)	Hours. Value x 100 Limit after which E09 appears
51	Service Function by Days	30 - 200	140 (about 4 years)	Days. Value x 10 Limit after which E09 appears
52	Service Function management (E09)	0 - 3	0	0 – Disabled (reset counters) 1 – Based on HOURS (par. 50) 2 – Base on DAYS (par.51) 3 – based on both: first HOURS, then DAYS
53	Total Hours from Installation	00 - 999	Only Reading	Hours x10 Total Working Hours from first Installation of PCB (max 9999h=about 5 years)
54	Total Hours from Service Function	00 - 999	Only Reading	Hours x10 Total Working Hours from last Service Function (E09) (max 9999h=about 5 years)
55	Total Days from Installation	00 – 999	0	Days x10 Total Working Days from first Installation of PCB (max 9999h=about 27 years)
56	Total Days from Service Function	00 – 999	0	Days x10 Total Working Days from last Service Function (E09) (max 9999h=about 27 years)
60	COMBUSTION Configuration code	0 – 7	Kind of Boiler	7 : 25 kW 6 : 35 kW
61	HYDRAULIC Configuration Code	0 – 8	Kind of Boiler	1: City Top
67	Firmware revision		Only Reading	Firmware of PCB software

AUTOMATIC CALIBRATION Based On Tolerances Of Components.

NO opportunity to modify these calibration values

The main PCB checks physical limits of main components, in order to supply them with right values and getting a good combustion quality.

- Set **par. 49** at value **5**
- Exit parameter mode pressing  and put boiler **ON** (Winter or Summer)
- Keep pressing buttons  and 
- After 6 sec, release previous buttons; display shows **HI**, press  release it when display shows **AUTO**

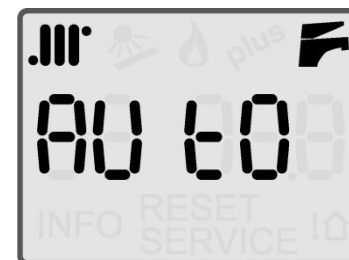
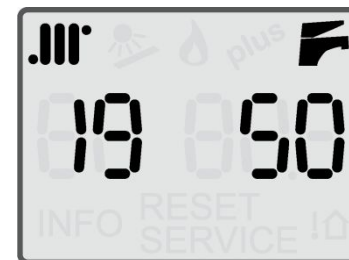
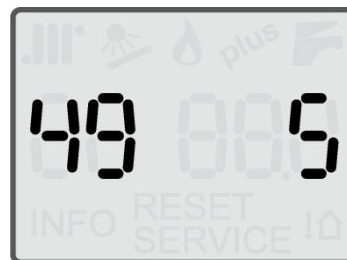

- Boiler starts AUTOMATIC Calibration
 - it starts calibrating appliance on Max power “HI”
 - then calibrating Ignition power “ME”
 - finishing with Min power “LO”
- On the right of display it is shown “ - - - ” for each Power (HI, ME, LO)

This means “CALIBRATION is RUNNING in this boiler power”

(Complete Calibration could take approximately 10 min)
- Once finished Calibration on “LO” power, on the right side of display, a number is shown. This is “Calibration Value” for LO power and it is stored on PCB.

+ .III* - .III*
- Pressing or is possible to scroll other powers (ME or HI) just for checking different Calibration Values on different Boiler power, but...
- DO NOT MODIFY VALUES ON THE RIGHT:**
Boiler Could Not Working Property
- Exit Calibration pressing for 2 sec.

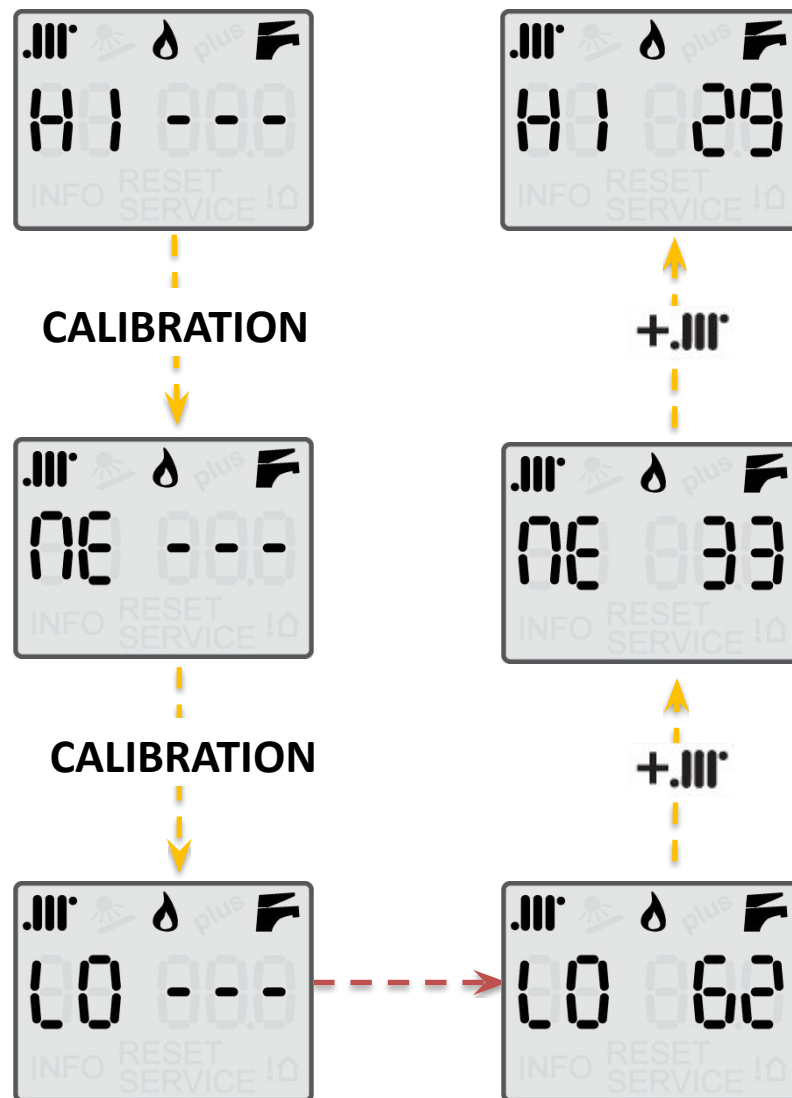

MANUAL CALIBRATION for fine adjustment of CO2 values



Opportunity to modify the values of CO2 found during AUTOMATIC Calibration

- Set **par. 49** at value **0**

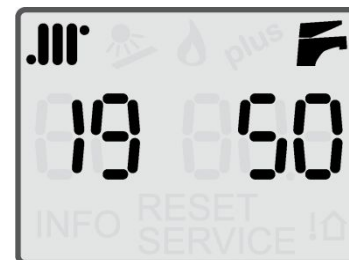

- Exit parameter mode pressing  and put boiler **ON** (Winter or Summer)



- Keep pressing 6 sec. buttons  and 



- After 6 sec, release previous buttons; display shows **HI**, press  release it when display shows **MANU**



- Boiler starts MANUAL Calibration
 - it starts calibrating appliance on Max power “HI”
 - then calibrating Ignition power “ME”
 - finishing with Min power “LO”
- On the right of display it is shown “ - - - ” for each Power (HI, ME, LO)
 - This means “CALIBRATION is RUNNING in this boiler power”
 - (Complete Calibration could take approximately 5 min)
- Once finished Calibration on “LO” power, on the right side of display, a number is shown **0** (zero)
- This number can be changed pressing or , between ± 3 (step 1);
Every step means about $\pm 0,1-0,2\%$ di CO₂
- Pressing or is possible to scroll other powers (ME or HI) and acting on that value for finding the best combustion value you can
- Exit Calibration pressing for 2 sec.

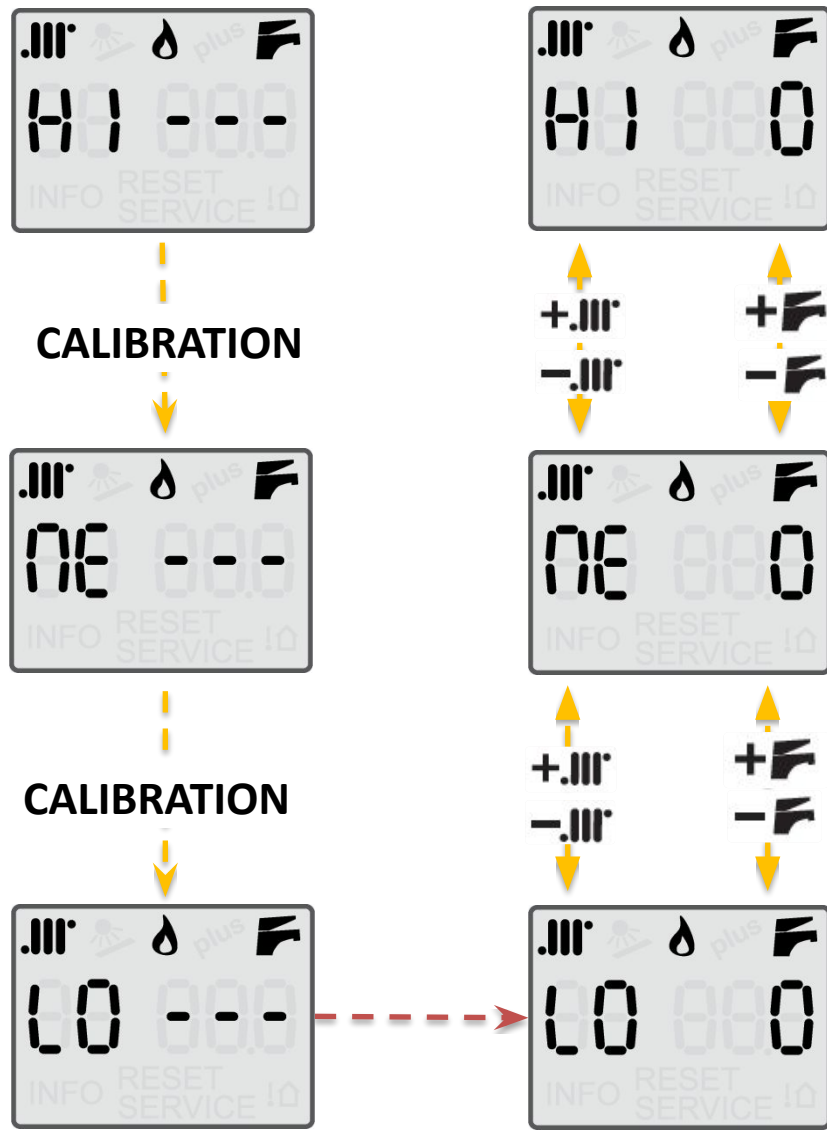

Operation / Components Replaced	Advised Procedure on Boiler		
	# 1	# 2	# 3
<i>Gas Conversion</i>	AUTOMATIC CALIBRATION	Check Combustion (CO2 values)	If necessary, MANUAL CALIBRATION
<i>Main PCB</i>	AUTOMATIC CALIBRATION	Check Combustion (CO2 values)	If necessary, MANUAL CALIBRATION
<i>Gas Valve</i>	AUTOMATIC CALIBRATION	Check Combustion (CO2 values)	If necessary, MANUAL CALIBRATION
<i>Fan</i>	AUTOMATIC CALIBRATION	Check Combustion (CO2 values)	If necessary, MANUAL CALIBRATION
<i>Combustion Chamber</i>	AUTOMATIC CALIBRATION	Check Combustion (CO2 values)	If necessary, MANUAL CALIBRATION
<i>First Commissioning</i>	Check Combustion (CO2 values)	If necessary, MANUAL CALIBRATION	--
<i>Burner</i>	Check Combustion (CO2 values)	If necessary, MANUAL CALIBRATION	AUTOMATIC CALIBRATION
<i>Detection/Ignition Electrode</i>	Check Combustion (CO2 values)	If necessary, MANUAL CALIBRATION	AUTOMATIC CALIBRATION
<i>Gas nozzle</i>	Check Combustion (CO2 values)	If necessary, MANUAL CALIBRATION	AUTOMATIC CALIBRATION
<i>Air-Gas Mixer</i>	Check Combustion (CO2 values)	If necessary, MANUAL CALIBRATION	AUTOMATIC CALIBRATION

Configuration Code is placed close to the control panel and it is visible leaving metal cover

City Class 25 K

G20

10710

G30/G31

11710

City Class 35 K

G20

10610

G30/G31

11610



G20

10710

Digits	1st	2nd	3rd	4th	5th
Value	Aesthetic	Gas type	Power	Hydraulic	Not used

Once replaced PCB or after «Total RESET» procedure, Boiler has to be configured for model where it is mounted

- Display shows “Co nFE”



- Keep pressing buttons  and : this way PCB recognize **Boiler Aesthetic** (1st digit)

- Set Parameter* 60 (**Boiler Power**), which is equal to 3rd digit of Configuration Code, on left corner of Control Panel (i.e. 1 on picture) and store value pressing **RESET**.



- Set Parameter* 61 (**Boiler Hydraulic**), which is equal to 4th digit of Configuration Code, on left corner of Control Panel (i.e. 2 on picture) and store value pressing **RESET**.



- Ending, PCB shows Configuration done.

On display and on the sticker there must be the same **Configuration Code**

City Class 25 K

G20

10710

G30/G31

11710

City Class 35 K

G20

10610

G30/G31

11610

TOTAL RESET = PCB is forced to factory settings

It is advised for solving some puzzling problem on the field

- Boiler Mode **OFF**

- Keep pressing for 15 sec buttons  and  and 

- When display shows “-” sliding, release button and press  to confirm procedure.

- Display switches OFF and switches ON again showing “Co nFE”
It means: “I need **AESTHETIC CONFIGURATION** !”



After this procedure, Boiler needs PCB Configuration

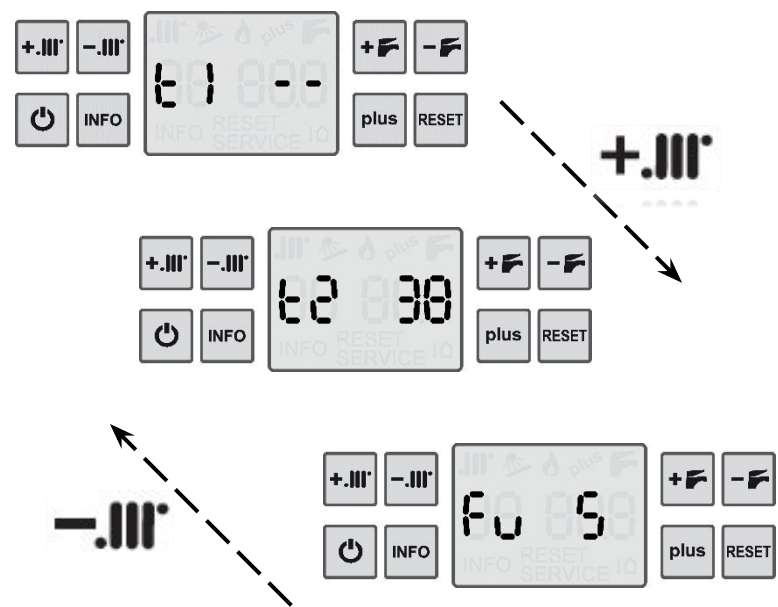
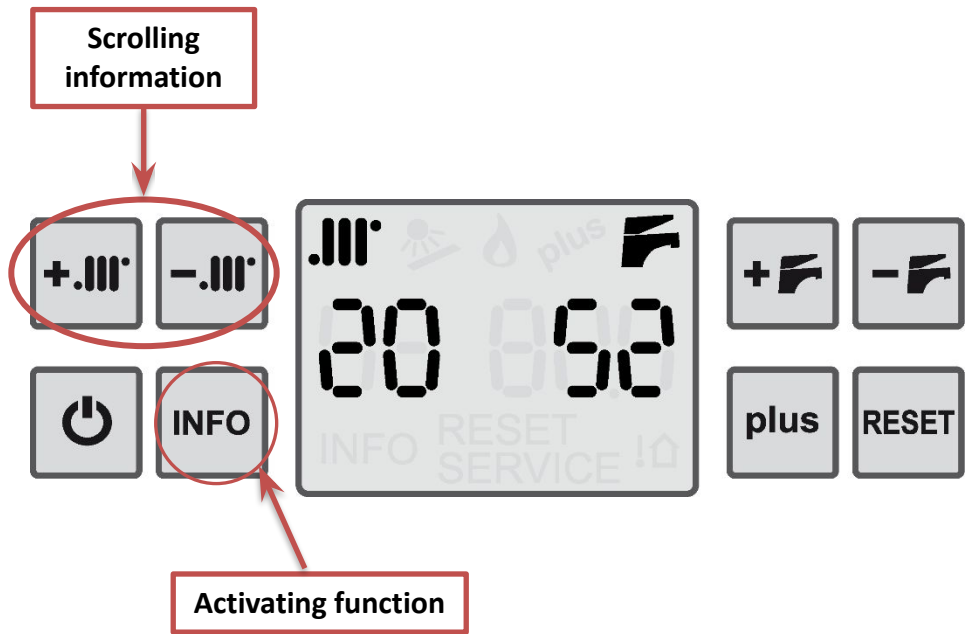

With a mode selected (summer or Winter) press

Info shown:

- t1** : External Temperature (if present)
- t2** : Return Temperature
- t3** : not used
- t4** : not used
- P** : Plant Pressure
- Fu** : Boiler Status code

- 0** : No Heat demand present
- 1** : TA1 CH demand present
- 2** : TA2 CH demand present
- 3** : TA3 CH demand present
- 4** : CH antifreeze function (T CH <5°C)
- 5** : DHW demand present
- 6** : Pre-heating mode
- 7** : DHW antifreeze function (if Temp DHW <5°C)

Exit function keep pressing

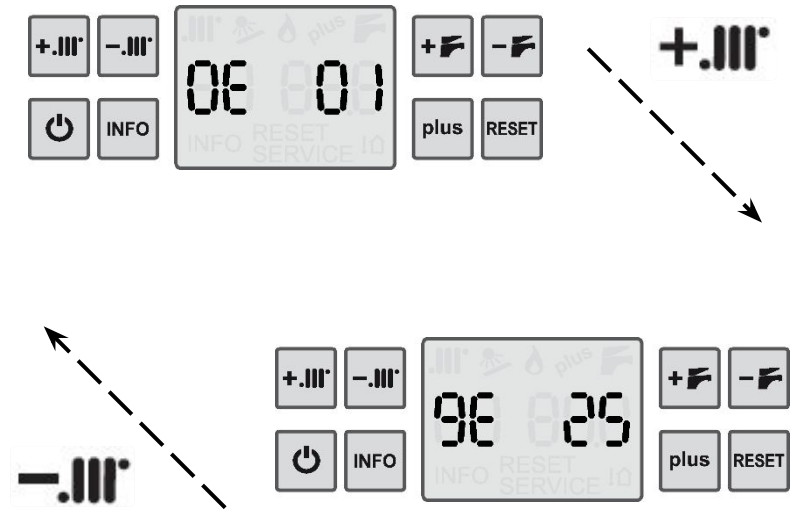
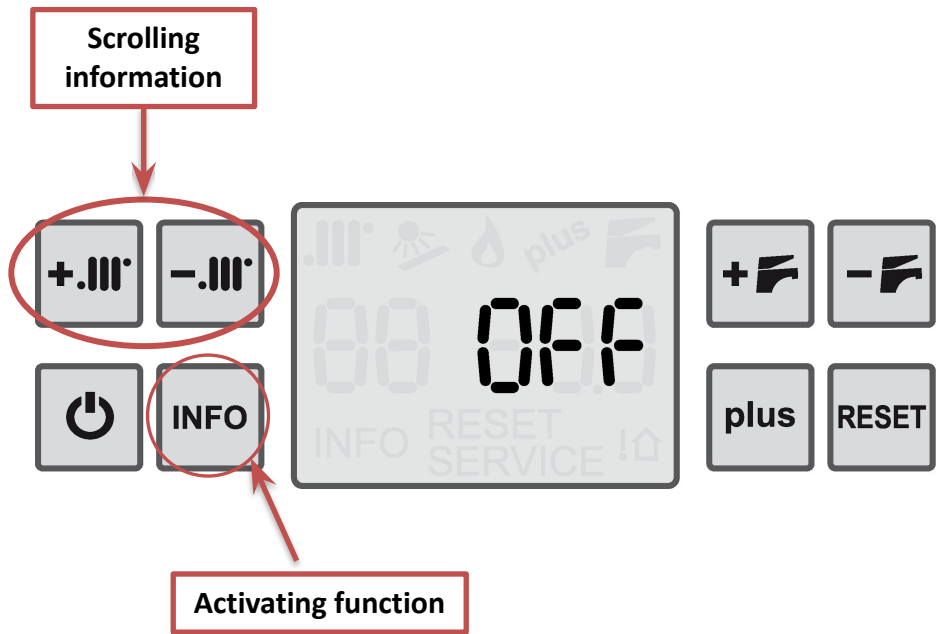

With mode **OFF** press

It shows **last 10 errors code**.

0E means **last error** appeared chronologically, **9E** is the **10th error** appeared chronologically).
“Number” on the right is **Code Error**.

Exit function keep pressing

Boiler keeps the primary temperature (on the main exchanger) in a pre-heating range chosen by Par 11. In this way boiler provides DHW quicker than standards instantaneous boiler

1. With a mode selected (summer or Winter) press briefly **INFO**
2. Symbols **plus** and **F** will be flashing; temperature showed is the current DHW detected.

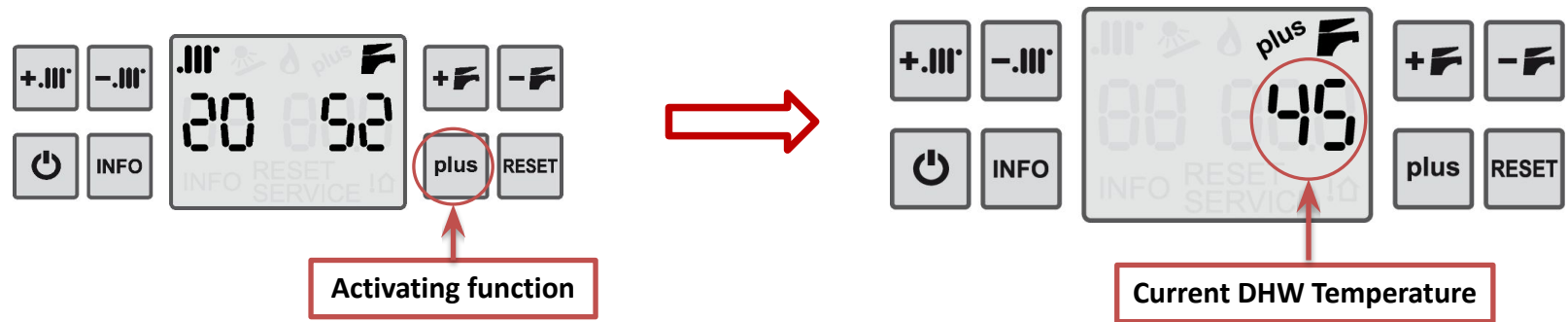

1. With a OFF mode selected keep pressing **INFO** for 3 sec.
2. Change the range value by pressing **+F** **-F**
3. Store the value by pressing **RESET**

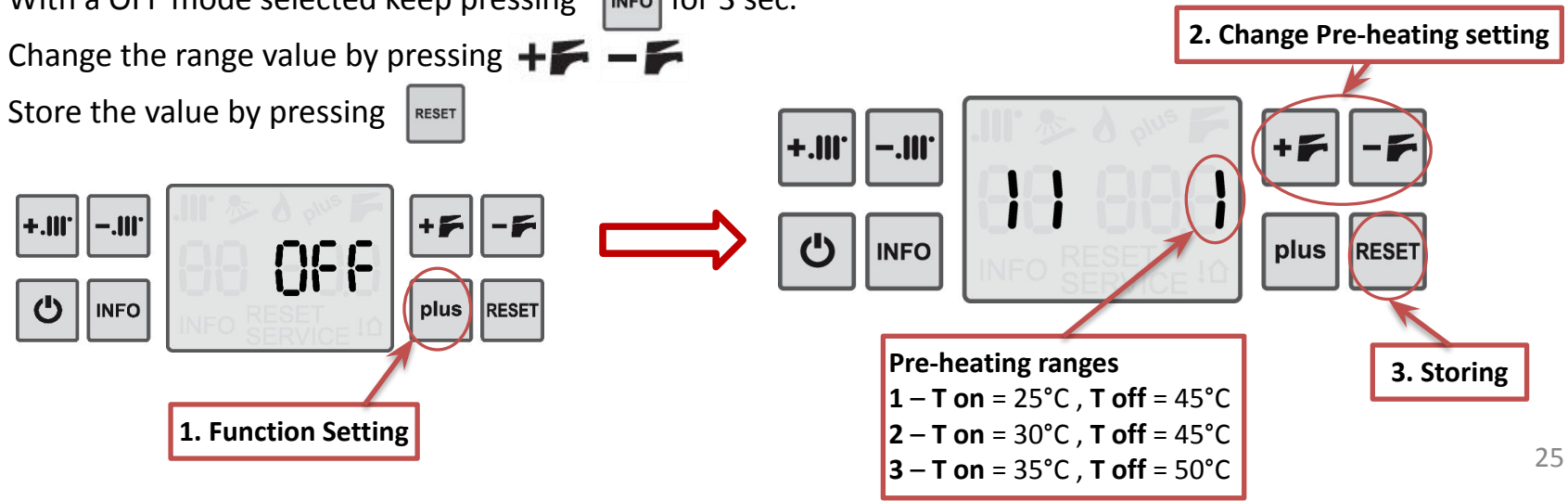

RESET = Pressing Reset, Error disappears and Boiler restarts

SERVICE = Boiler rerstarts only if root cause is OFF

Code	Error Kind	Description	Suggestion
E01	RESET	No flame ignition (after 5 attempts)	<ul style="list-style-type: none"> Gas pressure inlet Electrode position PCB
E02	RESET	High Water Temperature on Primary (Safety Thermostat)	<ul style="list-style-type: none"> Safety Thermostat Water plant circulation on the plant
E03	RESET	High Flues Temperature (Thermofuse)	<ul style="list-style-type: none"> Flues configuration Cleanness main exchanger
E05	SERVICE	CH NTC probe out of order	<ul style="list-style-type: none"> CH Probe Water plant circulation on the plant
E06	SERVICE	DHW NTC probe out of order	<ul style="list-style-type: none"> DHW Probe
E07	SERVICE	Max Reset Alarms number Reached (5 times)	<ul style="list-style-type: none"> Check last errors for service
E08	SERVICE	Flame lost 6 time after being detected	<ul style="list-style-type: none"> Flues mixed with air back to boiler Electrode positioning
E09	SERVICE	Service Function needed	<ul style="list-style-type: none"> Reset the counter of Maintenance function
E13	SERVICE	Gas Valve not supplied electrically and after 6 PCB Reset	<ul style="list-style-type: none"> Gas valve connection Gas valve functioning
E15	SERVICE	Return NTC probe out of order	<ul style="list-style-type: none"> Return probe

Code	Error Kind	Description	Suggestion
E16	RESET	Revolutions fan not correct	<ul style="list-style-type: none"> • Fan • PCB
E17	SERVICE	Buttons Anomaly (if a button remains pressed)	<ul style="list-style-type: none"> • Check Keyboard buttons
E18	-----	Automatic Water filling is running	<ul style="list-style-type: none"> • Check if filling is correct, bleeding the plant
E19	SERVICE	Automatic water filling failed (more than 'minutes' in PAR 37)	<ul style="list-style-type: none"> • Check if filling is correct, bleeding the plant
E21	SERVICE	3 automatic water filling attempts in 24 h	<ul style="list-style-type: none"> • Check if there is water inlet or a plant leakage
E23	SERVICE	Electric supply Frequency not correct (not 50 Hz \pm 1)	<ul style="list-style-type: none"> • Inlet electric supply
E24	RESET	Floor plant Thermostat open	<ul style="list-style-type: none"> • Check on connector X10 on PCB
E25	SERVICE	Boiler AUTOMATIC Calibration needed after PCB replacement	<ul style="list-style-type: none"> • Make Automatic Calibration
E29	SERVICE	Flues Pipes close completely or partially	<ul style="list-style-type: none"> • Check flues configuration • Check presence silicon gasket
E31	SERVICE	Wrong communication between Boiler and Remote Control	<ul style="list-style-type: none"> • Procedure to connect Remote control • Connection wire shielded

Code	Error Kind	Description	Suggestion
E35	RESET	Spurious Flame (Detection while no flame)	<ul style="list-style-type: none"> • Electrode positioning
E38	SERVICE	External probe out of order	<ul style="list-style-type: none"> • Check external probe
E39	SERVICE	Antifreeze function	<ul style="list-style-type: none"> • Check boiler and ice
E43	SERVICE	High Temperature felt by Return Probe (>85°C for 10 sec)	<ul style="list-style-type: none"> • Plant circulation • Pump
E44	SERVICE	Plant Circulation uncorrect (T Flow is increasing > +5°C/sec)	<ul style="list-style-type: none"> • Plant circulation • Pump
E45	SERVICE	Flow and Return NTC probe are inverted (if T Return > T Flow +10°C for 10 sec)	<ul style="list-style-type: none"> • Probes positioning • Plant circulation • Pump
E50	SERVICE	Electric supply Voltage not correct (under 160 V)	<ul style="list-style-type: none"> • Inlet electric supply
E91	SERVICE	Transducer out of order	<ul style="list-style-type: none"> • Replacer transducer
E92	SERVICE	High pressure in the plant (> 2,6 bar)	<ul style="list-style-type: none"> • Inlet electric supply not under specifications

GRAZIE PER LA VOSTRA ATTENZIONE!

THANKS FOR YOUR ATTENTION!

MERCI DE VOTRE ATTENTION!

GRACIAS POR SU ATENCIÓN!

СПАСИБО ЗА ВНИМАНИЕ!

感谢您的关注



Green Heating Technology

ITALTHERM